

# OSCAT

Open Source Community for Automation  
Technology

Presentation

Jan 2011



OSCAT

# *What is OSCAT*

- Library for IEC61131-3
- Hardware independent
- Open Source
- License free
- Distributed development community



# ***OSCAT Mission***

OSCAT Creates open source libraries for IEC61131-3 for all basic needs.

OSCAT focuses on portability and standardization among the great variety of PLC hardware platforms.

OSCAT shares its IP among all PLC programmers and greatly benefits from the experience and input of it's users.



# *OSCAT History*

- Aug. 2006 Library 1.0 for Codesys 2.3
- Feb. 2007 Library 1.4 for STEP7
- Jan. 2008 Library for PC Worx Multiprog
- Apr. 2008 added Support for Codesys 3.0
- Nov. 2009 release of OSCAT Network Lib 1.0
- Jan. 2011 Network Lib supports Beckhoff
  
- Current version: Basic 3.21 & Network 1.10



# Available Libraries

	Codesys 2.3	Codesys 3.0	Step 7	PCWorx
OSCAT BASIC	<b>3.21</b>	<b>3.21</b>	<b>3.20</b>	<b>3.21</b>
OSCAT Network	<b>1.10</b>			<b>1.10</b>
OSCAT Building	<b>Q1 / 2011</b>	<b>Q1 / 2011</b>		<b>Q1 / 2011</b>
OSCAT File System				



# *Open Source Library*

- Easy transfer between different systems
- 100% open source code
- Tested on multiple Hardware platforms
- Tested in various applications
- Highly optimized code for best performance
- Continuous maintenance
- frequent releases and updates
- detailed revision and release history
- revision tracking on module level



# IEC61131-3 Standard ?

- Different programming languages
- Basic programming statements
- Manufacturer specific libraries
  - No Source Code, Debugging complicated
  - No Standard for complex modules
  - Modules can't be adopted or changed
- Hardware change is tough because libraries are bound to Hardware
- Various implementations of standard
  - Different CPU's behave differently
  - MOD, TRUNC, ....
  - Date and Time is not Standard
  - MUX, MIN, MAX, ....



# before OSCAT

APP 1

APP 2

APP 3

APP 4

Lib 1

Lib 2

Lib 3

Lib 4



OSCAT



# with OSCAT

Independent APPLICATION

OSCAT Library



OSCAT

# OSCAT Structure

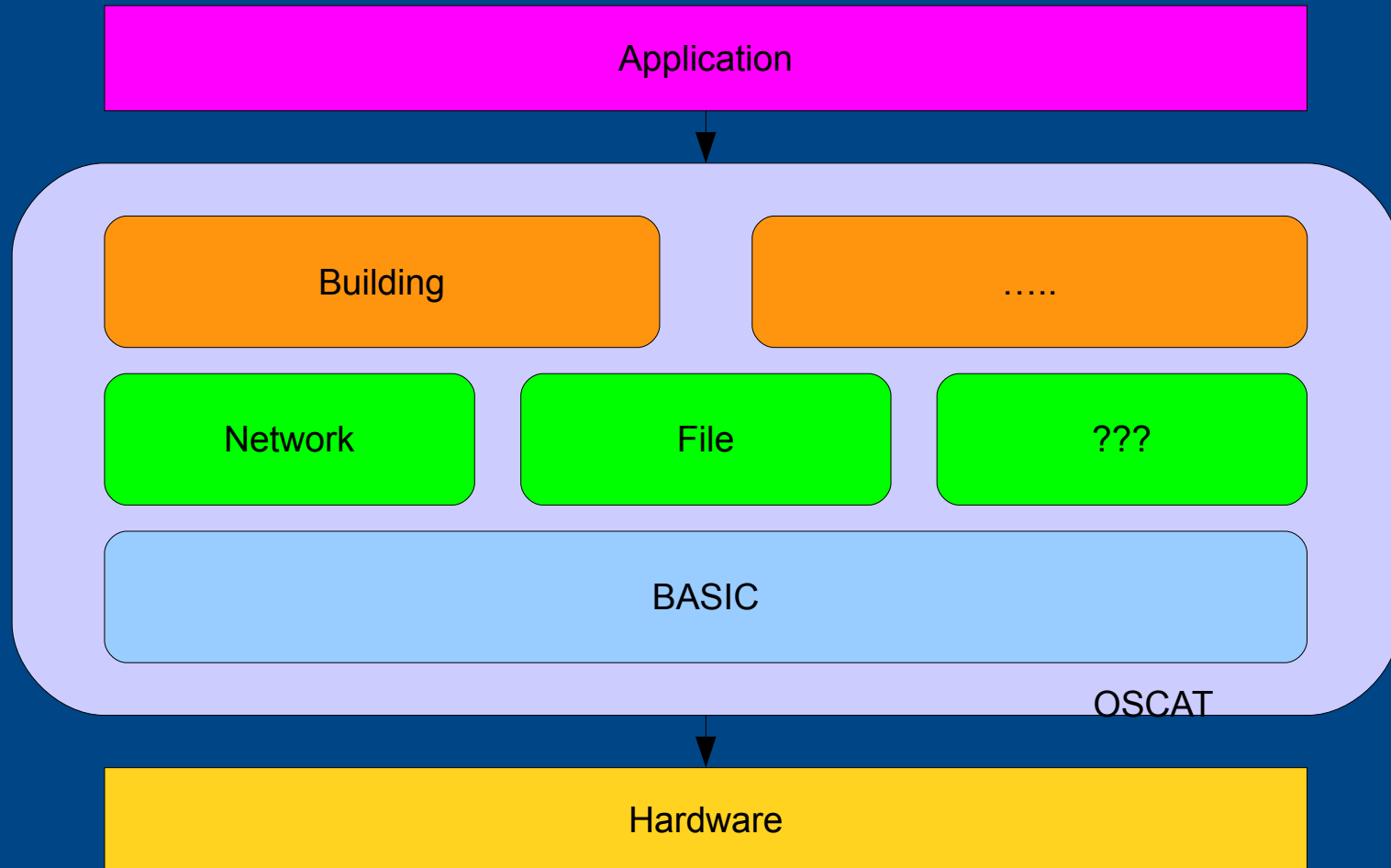

# *OSCAT advantages*

- Independent of Development Tools
  - Codesys 2
  - Codesys 3
  - PCWorx
  - Step7
  - More to come
- Independent of Hardware
- Open Source for Debugging
- Change and create your own



# *Cross Platform availability*

- Codesys 2
- Codesys 3
- Multiprog / PC-Worx
- STEP7
- Text format for easy import in other systems
- Based on IEC61131-3 functions
  
- Hardware tested on multiple Platforms / CPUs
  
- Further Platforms in preparation



# OSCAT Platform Usage

Data from OSCAT user Forum December 2008

OSCAT is used on the following platforms

- Codesys 2.3 43%
- Twincat 19%
- Step 7 19%
- Codesys 3.0 6%
- PCWorx/MProg 6%
- Andere 8%

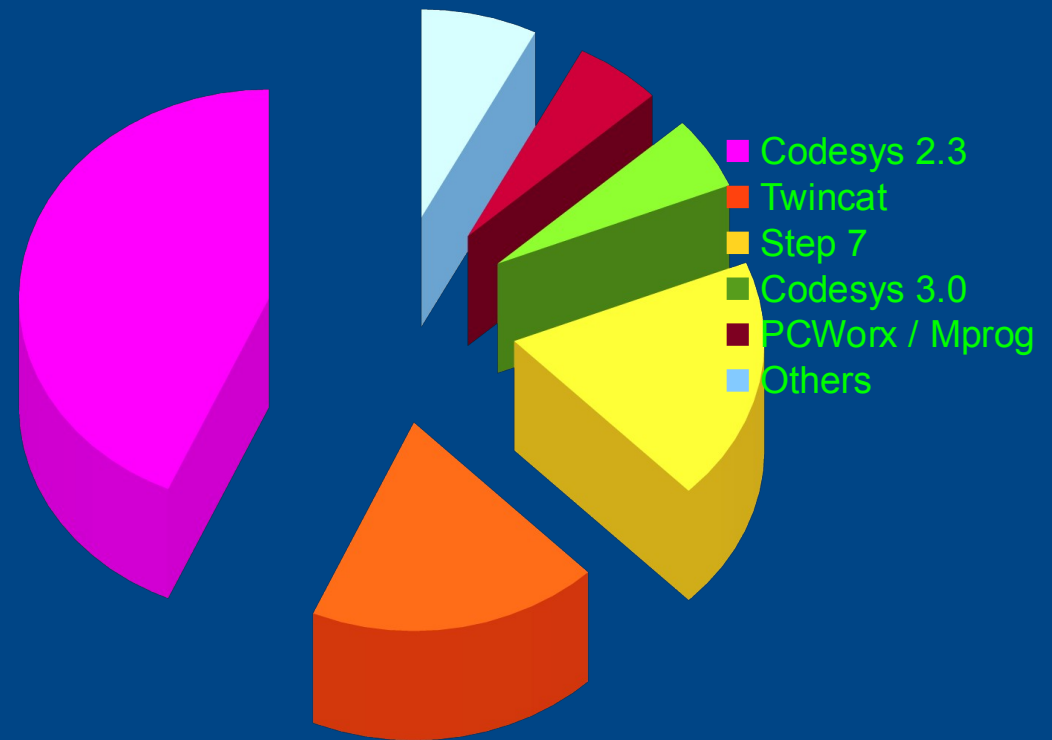

# OSCAT Hardware Usage

Data from OSCAT user Forum December 2008

OSCAT is used with the following Hardware

•Wago	29%
•Beckhoff	22%
•Siemens	19%
•Moeller	9%
•Micro Innovation	6%
•Andere	15%

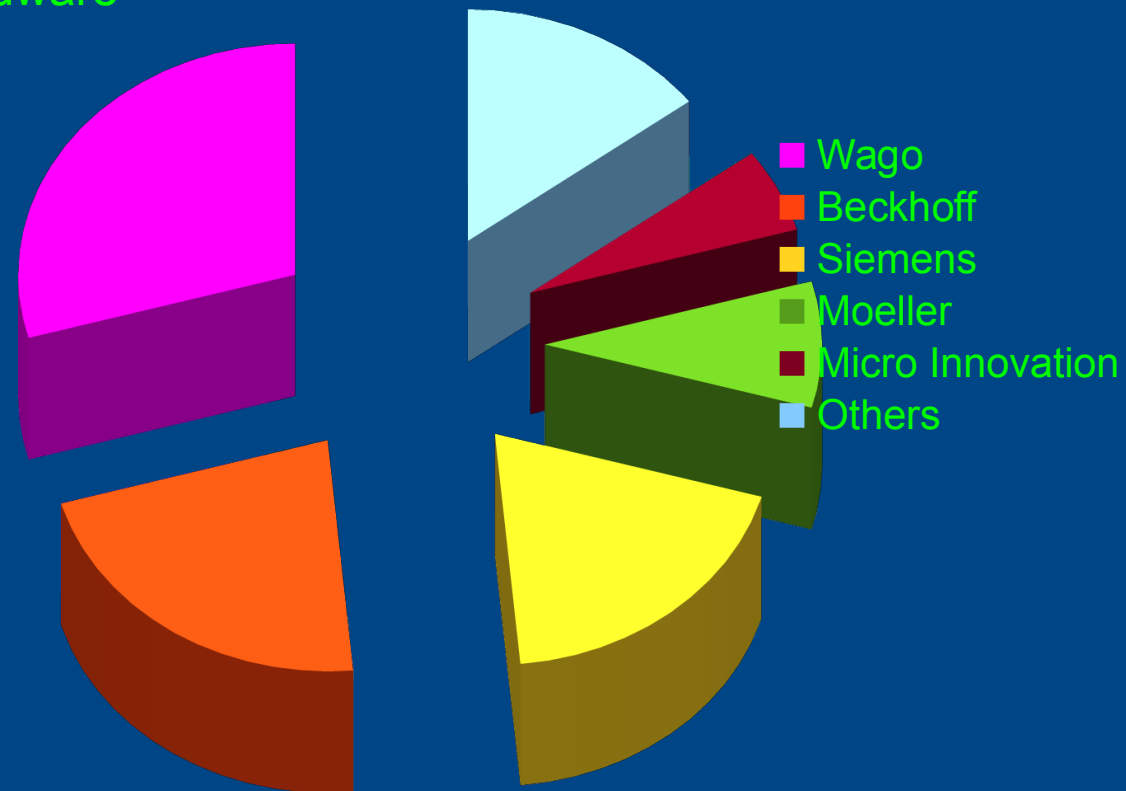

# *Testing and Verification*

- Development on different systems assures independence of code
- Runtime tests on different hardware systems
- Testing with random patterns
- Test of math functions to 6 digits resolution
- Test program for all functions
- Projects verify the library on different systems
- Verification under different development systems
- OSCAT works together with most other libraries



# *Most complete Library*

- The OSCAT Library keeps growing
- Continuous improvement of code
- Inputs from many users and applications
- Open source guarantees flexibility
- OSCAT is optimized for 32 bit non FPU CPUs
- Extraordinary performance also on 16Bit CPUs





# *OSCAT components*

- Over 800 Library Modules available
- Mathematics
- Time/Date
- String / List / Buffer
- Networking
- Automation / Control
- Networking
- .....



# Buffer Management [7]

- Modules to handle large arrays of Byte
- Initialization and clear  
\_BUFFER\_INIT, \_BUFFER\_CLEAR
- Insert and retrieve from Buffer  
\_BUFFER\_INSERT, \_STRING\_TO\_BUFFER, BUFFER\_TO\_STRING
- Searching  
BUFFER\_SEARCH



# *List Management [9]*

- Modules to handle lists
- Lists are multiple elements separated by a separation character stored in STRING(255)
- Insert and retrieve from list
- Evaluate length of list LIST\_LEN
- Clean list from empty elements



# *Building Automation [47]*

- Actuators for Valves, Flaps, Pumps...
- Electrical, Switches, Dimmers, Timers...
- HVAC
- Blind Control



# Blind Control Example

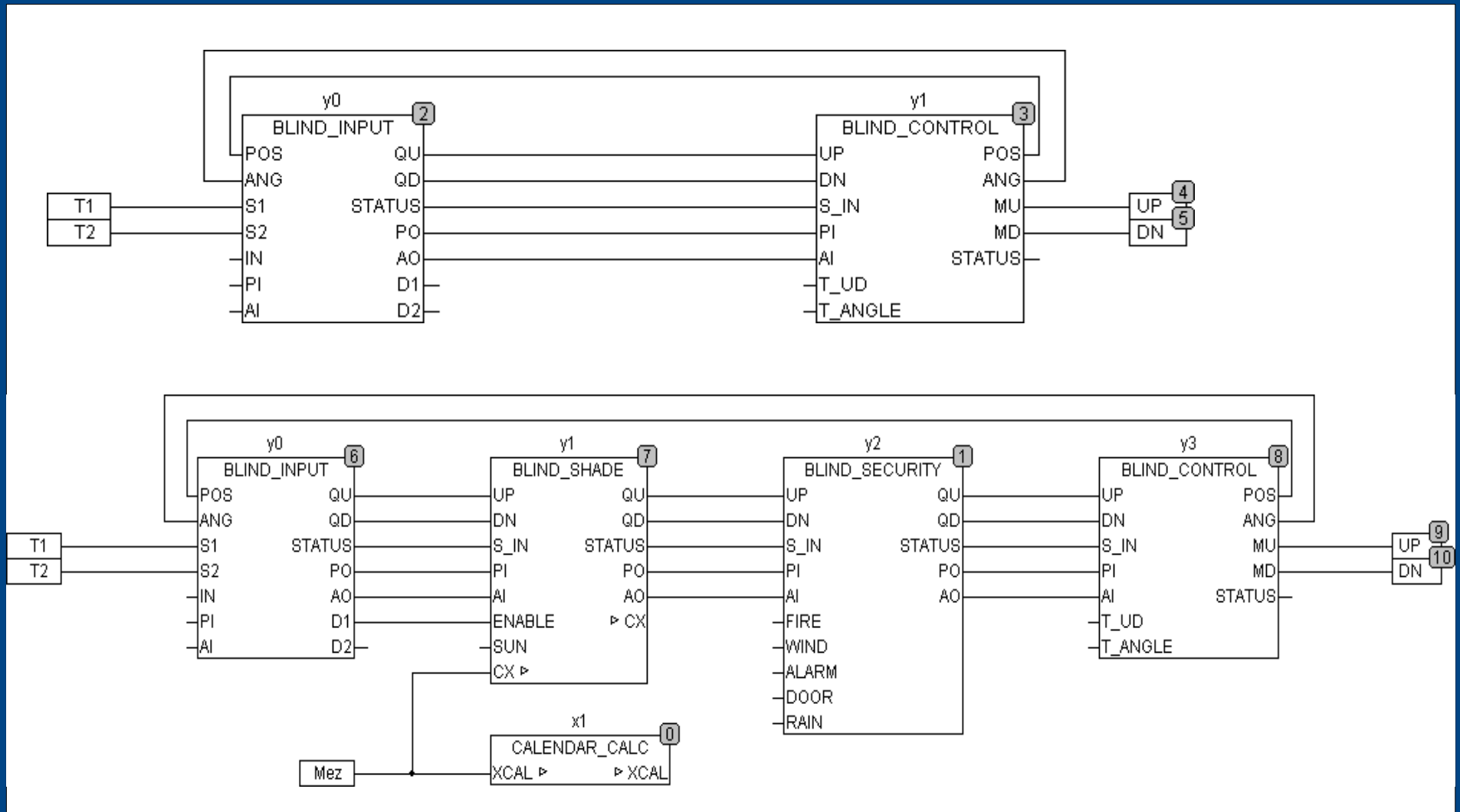

# *Device Drivers [4]*

- Interfaces to Standard Devices
- IRTRANS Infrared Transceivers over TCP/IP
- Decoder for DCF77 receiver



# *Automation [27]*

- Incremental decoder with quad resolution
- Profile generation
- Drivers
- Signal generators
- Interlock
- Tuning
- .....



# Control [34]

- **Basic building blocks**  
Integrator, Differentiator, LT1, LT2, Delay...
- **Advanced building blocks FT\_PI, FT\_PDT1 ...**
- **Anti Wind-Up circuitry**
- **Modular controller design and building blocks**
- **Regulators PID, PI, Hysteretic ....**
- **Control set calculation for PI and PID**
- **Signal Filters**





# Conversion [30]

- Converting between different Units:
- Temperature
- Pressure
- Length
- Speed
- Compass directions
- Wind Speeds
- .....



# *Measurement [12]*

- Calibrate, Offset, Scale
- Bar graph Lin or Log
- Cycle time, ontime
- Time and Pulse measurement
- Ontime with 64 Bit resolution
- Consumption Meter and Statistics



# *System Time Base [5]*

- T\_PLC\_MS() and T\_PLC\_US()
- Standard interface for reading the system timer
- Millisecond and microsecond resolution
- Debug functions for overflow
- Debug functions for speed increase to test slow processes.
- TC\_MS, TC\_US, TC\_S returns cycle time in microseconds, milliseconds or seconds



# *Sensor Interface [10]*

- PT, NI, SI, NTC Sensor formulas
- Calculate temperature from resistance
- Calculate resistance from temperature
- Scale and offset calibration
- Compensation for parasitic resistors
- Redundant Analog or Digital sensor interfaces



# Signal Generators [15]

- Standard functions  
SIN, triangle, ramp, square wave
- Adjustable offset, delay and amplitude
- Pulse and Bitmap generators
- Modulated generators, PWM
- Controlled Ramp Functions
- Random time and pulse generators
- Time and Logic Sequencers



# *Signal Processing [42]*

- Transfer functions for analog signals
- Input and output adjustments for A/D and D/A
- Sample and hold circuits
- Multiplexing and Fading
- Signal Delay
- Offset, Override and Mixing Functions
- Scaling for byte and boolean inputs
- Staircase functions



# *Boolean Logic [81]*

- Flip flops, latches and shift registers
- Edge and ramp triggered logic
- CRC and parity functions
- Matrix keyboard scanner
- Stack and fifo memory
- TP\_R Pulse generator retriggerable
- B\_TRIG, DTRIG Trigger any edge or DWORD
- Programmable pulse generators or sequencers
- Conversion BCD, DWORD, BYTE, HEX



# Networking [11]

- Support for TCP/IP and UDP
- Basic functions for protocol stacks and communication
- SNTP simple network time protocol
- IPv4 address decoder
- DNS resolution
- HTML coding and decoding
- XML parsing
- Yahoo weather
- .....





# ESR [4]

- Error and Status Reporting
- Standardized interface to OSCAT building blocks for data logging, debugging and status reporting
- Event monitoring
- Collection of data and status of the process
- Time stamp and address label
- Interface to servers via TCP/IP
- Data and activity logging over TCP/IP



# ESR example

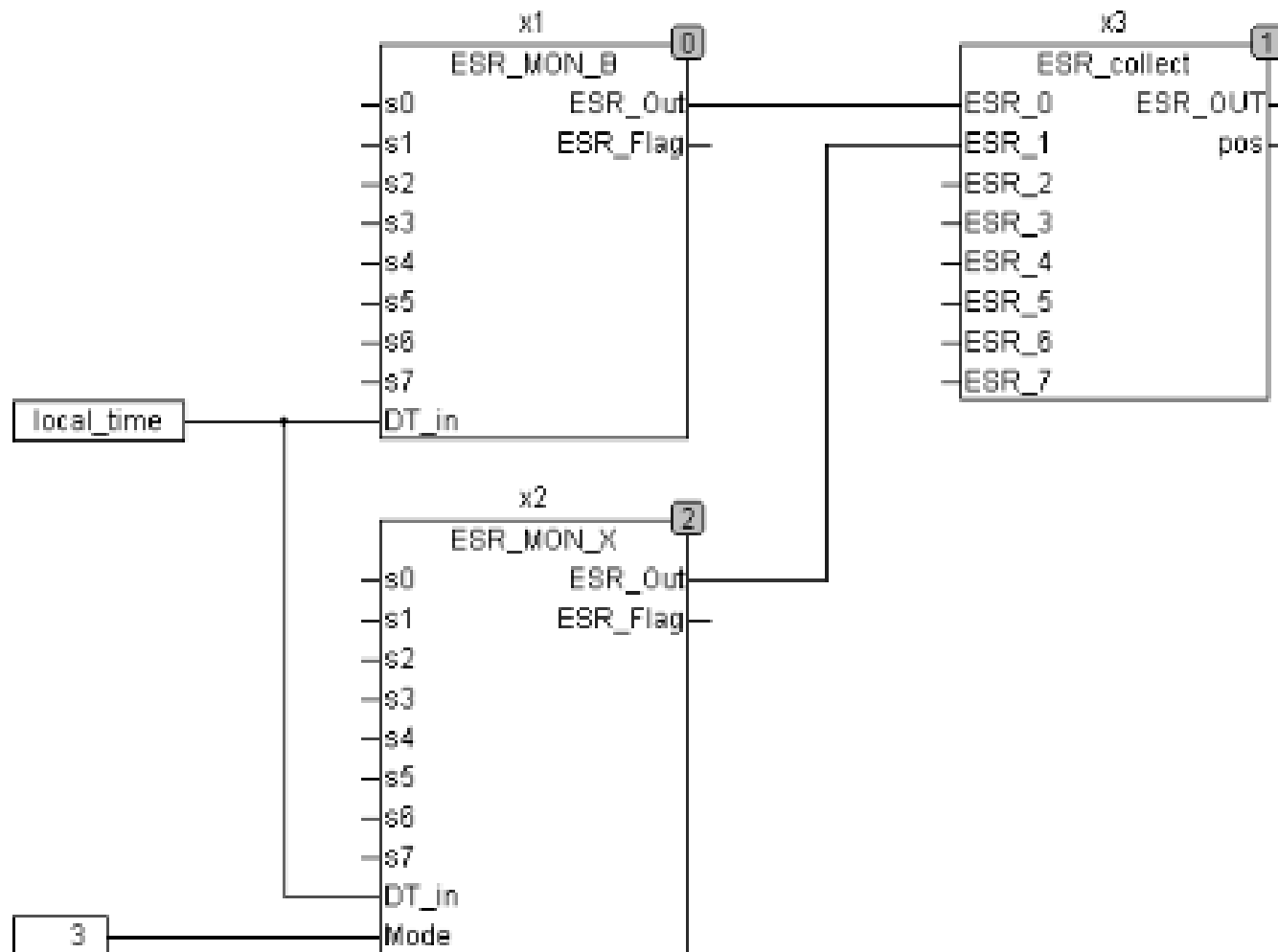

# *Mathematics [144]*

- Extensive mathematical functions over 100 mathematical functions
- Functions for complex numbers
- Functions for vector analysis
- Linear and polynom interpolation
- Geometry functions
- Array handling
- Statistical functions
- Double precision mathematics



# ***STRING [76]***

- Extensive string functions  
over 60 string functions
- Conversion functions
- Uppercase and Lowercase
- Support for extended ASCII > 127 (Ä,Ö,Ü)
- Enhanced FIND and Replace
- Trim functions
- String length up to 255 characters
- ....



# *TIME & DATE [51]*

- Extensive Time and Date functions
- RTC Blocks with millisecond resolution
- DCF77 receiver and decoder
- Date functions with adaption for STEP7
- Sun position, sun rise and sun set calculations
- Easter and holiday calculations
- Complete set of Date and Time calculations
- Structured time format and functions



# *Planned activities*

- Object oriented library
- Library for File Access
- Continuous improvement of performance
- Continuous maintenance and service releases
- Data logging over TCP/IP functions with JAVA code for Servers



# *License*

- OSCAT is free of charge
  - Private use
  - commercial usage
- No License agreement necessary
- Application Code does not have to be opened



# WWW.OSCAT.DE



**OSCAT**  
Open Source Community for Automation Technology

Home Forum

Home

MAIN MENU

- Home
- News
- Downloads
- LINKS/IMPRESSUM**
- Forum
- Impressum
- Administrator

SYNDICATE

- RSS 0.91
- RSS 1.0
- RSS 2.0
- ATOM 0.3
- OPML SHARE IT!

NEUESTE NEUIGKEITEN

- oscat.lib 3.03
- oscat.lib 3.02
- oscat.lib 3.01
- oscat.lib 2.77
- oscat.lib 2.76
- oscat.lib 2.75
- oscat.lib 2.74
- oscat.lib 2.73

WILLKOMMEN BEI OSCAT

Willkommen bei OSCAT, der "Open Source Community for Automation Technology". Seit dem 1. August 2006 bemüht sich OSCAT speziell darum ein Forum zu sein, in dem sich alle Interessierten austauschen können. Besonderen Wert legt diese Seite insbesondere auf die Programmierung von SPS (Speicherprogrammierbare Steuerungen). OSCAT entwickelt da... Anwendungen für den Home Automation Bereich dienen soll. Sie sind natürlich herzlich eingeladen, an der Weiterentwicklung der oscat.lib teilzunehmen und Kontakt treten. Ziel ist es, eine möglichst übersichtliche Bibliothek zu schaffen, die die wichtigsten Funktionen und Funktionsblöcke für Home Automation enthält.

NEUESTE DOWNLOADS

- oscat.lib 3.03 CoDeSys 3
- oscat.lib 3.03 Präsentation
- oscat.lib 3.03 TwinCAT / CoDeSys 2.3
- oscat.lib 3.03 Step 7
- oscat.lib 3.03 PC WorX/MULTIPROG
- oscat.lib 3.03 Plain text
- oscat.lib 3.03 Dokumentation
- oscat.lib 3.02 TwinCAT / CoDeSys 2.3

Zu den folgenden Themenbereichen, verknüpft mit der Idee des Smart Home, finden sich Informationen auf OSCAT:

- SPS-Programmierung und Projekte
- Entwicklung der oscat.lib für CoDeSys-Anwendungen
- Multimedia-Projekte
- Security-Projekte
- RFID-Anwendungen
- EnOcean-Anwendungen
- Integration von Bus-Systemen wie KNX, LON, BacNET
- Intelligente Haustechnik

NEUIGKEITEN

**oscat.lib 3.03**

Geschrieben von Tobias Mühlbauer  
Monday, 5. January 2009

Das Release 3.03 steht im Downloadbereich zur Verfügung:



# Downloads

- OSCAT.LIB CoDeSys 2.3 / Twincat
  - OSCAT.LIBRARY Codesys 3.4
  - OSCAT S7.ZIP STEP7
  - OSCAT PCW.ZIP PCWorx / Multiprog
  - OSCAT.TXT Plain text
- 
- OSCAT.PDF Manual (German)
  - HISTORY.PDF Revision history



# Manual

- 700 Pages (German)

## 16.19 DEC\_2

Type	Funktionsbaustein
Input	D : BOOL (Eingangs Bit) A : BOOL (Adresse)
Output	Q0 : BOOL (TRUE bei A=0) Q1 : BOOL (TRUE bei A=1)

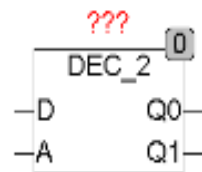

DEC\_2 ist ein 2-Bit Dekodierbaustein. Ist A=0, so wird der Eingang D auf Ausgang Q0 geschaltet. Ist A=1, so wird D auf Q1 geschaltet. Mit anderen Worten: Q0=1 wenn D=1 und A=0.

Logische Verknüpfung:  $Q0 = D \ \& \ /A$ ;  $Q1 = D \ \& \ A$

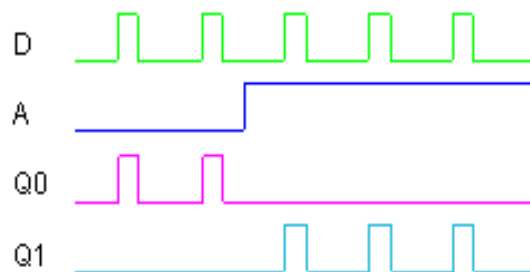













# Revision History

<u>Release</u>	<u>Modul name</u>	<u>Rev</u>	<u>Date</u>	<u>History</u>
304	BLIND_SHADE	1.3	08.02.09	<u>added calendar data structure</u> <u>Added shading position to be configured</u>
304	CALENDAR_CALC	1.1	08.02.09	<u>corrected wrong night calculation</u> <u>Added sun position data</u>
304	CALENDAR	1.1	08.02.09	<u>added sun position data</u>
304	METER	1.3	08.02.09	<u>changed MX to be I/O</u> <u>Make sure calculation works for cycle times &lt; 1ms</u>
304	HEAT_METER	1.6	08.02.09	<u>changed output Y to I/O</u>
304	LAMBERT_W	1.0	08.02.09	New Module
304	T_AVG24	1.1	08.02.09	<u>added outputs T24_MIN and T24_MAX</u> <u>Changed sign of input OFS</u>
304	DIMM_I	2.3	26.01.09	<u>dimming will reverse at 0</u> <u>Rst will override set</u>
304	FT_PIDWL	1.1	25.01.09	<u>multiply differential part with KP</u>
304	FT_PIWL	1.2	25.01.09	<u>now also works with negative K</u>
304	SCALE_X8	1.2	24.01.09	<u>corrected error in formula</u>
304	FADE	1.3	24.01.09	<u>delted unused var FF</u>
304	ACTUATOR_2P	2.1	24.01.09	<u>deleted unused var inb</u>
304	_RMP_NEXT	1.1	24.01.09	<u>deletes unused vars tmp1 and tmp2</u>
304	SUN_POS	2.0	23.01.09	<u>new code with better accuracy</u>
304	GEO_TO_DEG	1.0	22.01.09	New Module
304	BLIND_INPUT	1.5	22.01.09	<u>added auto mode for IN</u> <u>Added pulse mode for D1 and D2</u>
304	TO_UPPER	1.3	16.01.09	<u>corrected an error in module</u>
303	TEMP_NTC	1.0	30.12.08	New Module
303	RES_NTC	1.0	30.12.08	New Module
303	CLICK	2.0	28.12.08	<u>new code using library modules</u>
303	CONSTANTS_LOCATION	1.1	23.12.08	<u>added french holidays</u>



# USER FORUM

OSCAT			
	<b>Ankündigungen / Announcements</b> Ankündigungen und Neuigkeiten bezüglich OSCAT.	91 Beiträge 42 Themen	<b>Letzter Beitrag</b> von hugo in Re: Beta für Release 304 am Heute um 17:30
oscat.lib			
	<b>oscat.lib für TwinCAT/CoDeSys</b> Diskussion und Ankündigungen über die Kernbibliothek oscat.lib für TwinCAT/CoDeSys.	487 Beiträge 80 Themen	<b>Letzter Beitrag</b> von hugo in Re: Betriebsstundenzähle... am 07. Februar 2009, 21:02:57
	<b>oscat.lib für CoDeSys 3</b> Diskussion und Ankündigungen über die Kernbibliothek oscat.lib für CoDeSys 3.	7 Beiträge 4 Themen	<b>Letzter Beitrag</b> von elektrop in Re: Lib kann in CoDeSys ... am 21. November 2008, 09:15:08
	<b>oscat.lib für Step 7</b> Diskussion und Ankündigungen über die Kernbibliothek oscat.lib für Step 7.	206 Beiträge 44 Themen	<b>Letzter Beitrag</b> von eileen in Re: PWM im OB28 am Heute um 17:11
	<b>oscat.lib für PC WorX/MULTIPROG</b> Diskussion und Ankündigungen über die Kernbibliothek oscat.lib für PC WorX und MULTIPROG.	20 Beiträge 5 Themen	<b>Letzter Beitrag</b> von peewit in Re: einzelne bausteine e... am 08. Februar 2009, 12:10:19
	<b>Bestehende Module / Existing Modules</b> Fragen, Verbesserungsvorschläge und ähnliches zu bestehenden Modulen.	704 Beiträge 141 Themen	<b>Letzter Beitrag</b> von hugo in Re: IrTrans am 06. Februar 2009, 18:14:39
	<b>Modulentwicklung / Module Development</b> Diskussion und Entwicklung neuer Funktionen und Funktionsblöcke für die oscat.lib.	259 Beiträge 57 Themen	<b>Letzter Beitrag</b> von Vaninger in Re: Rezepturverwaltung am 17. Januar 2009, 23:06:43
	<b>Anwendungsbeispiele / Application Examples</b> Anwendungsbeispiele für die oscat.lib.	44 Beiträge 17 Themen	<b>Letzter Beitrag</b> von hugo in Benutzung der Datenstruk... am 09. Februar 2009, 17:40:46
	<b>Development Area</b> Entwicklerbereich für die oscat.lib (Nur für Entwickler sichtbarer Bereich!)	1166 Beiträge 67 Themen	<b>Letzter Beitrag</b> von doncamillo in Re: Regelungstechnikbaus... am Heute um 17:01
Home Automation			
	<b>SPS-Hardware</b> Diskussionen und Vergleiche von SPS-Hardware.	77 Beiträge 11 Themen	<b>Letzter Beitrag</b> von volkmarrigo in Re: Wago startet nicht u... am 23. Januar 2009, 20:41:59
	<b>SPS-Programmierung</b> SPS-Projekte im Rahmen der Home Automation abseits der oscat.lib.	178 Beiträge 39 Themen	<b>Letzter Beitrag</b> von Stanley in Re: Berechnung der Kalen... am 17. Januar 2009, 21:31:19
	<b>Multimedia</b> Diskussion von Multimedia-Projekten für das Smart Home.	2 Beiträge 2 Themen	<b>Letzter Beitrag</b> von sapo in MIDI Daten in Binäre Zus... am 08. August 2007, 17:23:31
	<b>Andere Projekte / other Projects</b> Diskussion von Projekten die nicht in die anderen Boards passen.	35 Beiträge 8 Themen	<b>Letzter Beitrag</b> von volkmarrigo in Re: Tool zum Loggen von ... am 12. Februar 2009, 20:27:38

# OSCAT forum page hits

(Quarterly Numbers)

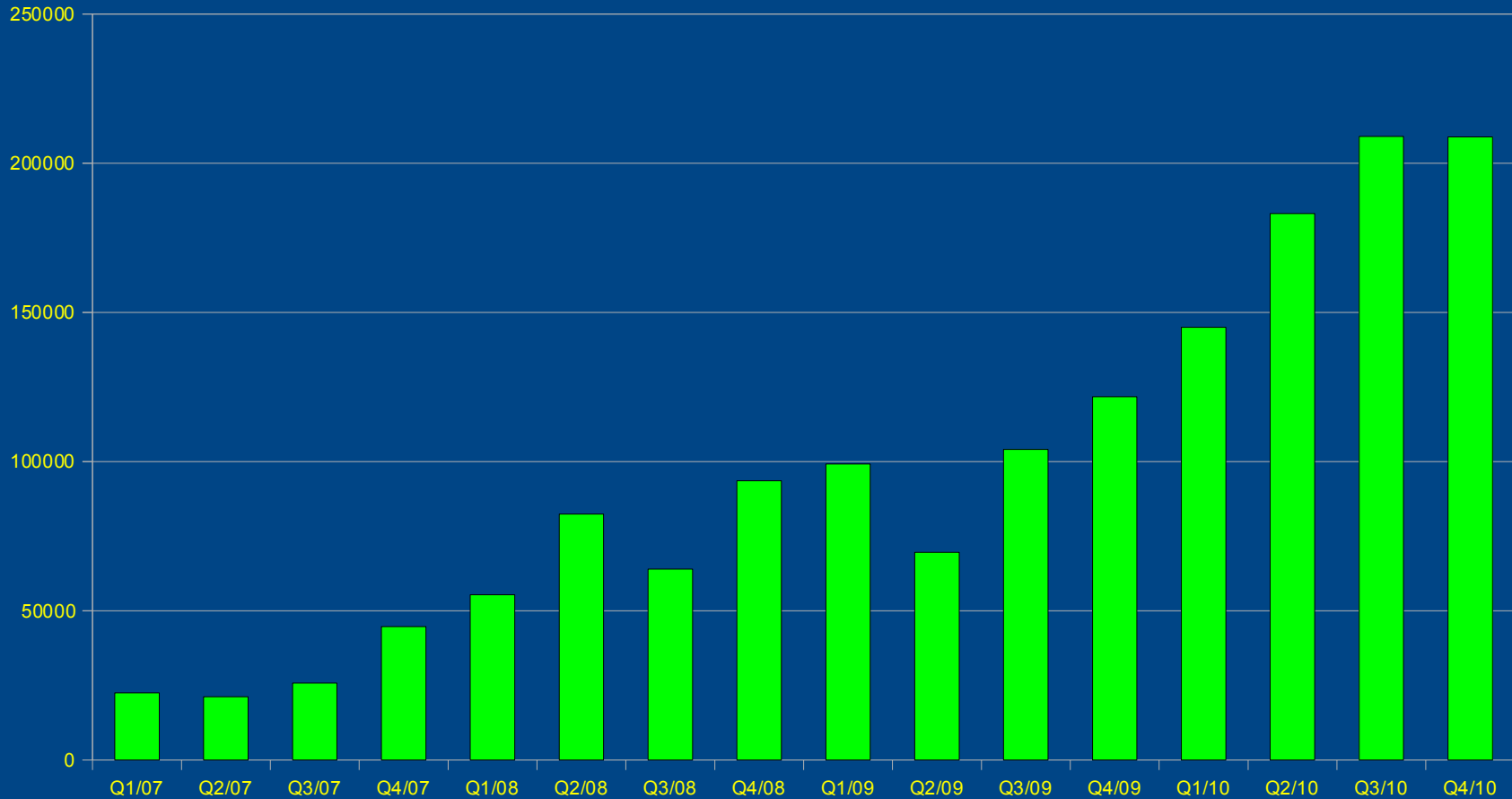

OSCAT

# Reference

Wir verwenden die OSCAT-Bibliothek in vielen Bereichen:

Gebäudetechnik (STEP7/Wago/Beckhoff)

Sondermaschinenbau (STEP7)

Automobilbau Klebetechnik (STEP7/Beckhoff)

Die reichhaltige Ausstattung mit Funktionen aus den Bereichen Zeit+Datum, Umrechnungen, String-Funktionen und Regelungstechnik können wir gut einsetzen.

Da wir sehr unterschiedliche Kunden bedienen ist ein weiterer Vorteil die Unabhängigkeit von der verwendeten Hardwareplattform.

Im Unterricht an der Handwerkskammer für München und Oberbayern bringen wir sie auch ins Spiel. Weitere Referenzen kann man auf unserer Web-Site [www.spssoft.de](http://www.spssoft.de) sehen.

Daniel Bonk

Geschäftsführender Gesellschafter SPS Soft GmbH München

# Reference

Wir setzen die OSCAT.LIB im industriellen Umfeld im Bereich der Kühlraumüberwachung und Kälteanlagensteuerung ein.

Weitere Funktionsfelder werden in Zukunft auch mit Hilfe der OSCAT.LIB implementiert werden:  
Lastausgleich,  
Energiemanagement /Max-Abschaltung,  
Produktionsanlagenautomatisierung mit Anbindung von Waagen.

Die OSCAT.LIB ist eine besonders gute Hilfe, und da sie ständig fortentwickelt wird, lohnt sich ein Besuch bei OSCAT.DE immer.

Als Einsteiger in die Welt der SPS bin ich sehr dankbar für die nützlichen und offen gelegten Funktionen.

Ich habe schon mehrfach durch den offenen Quellcode Anpassungen vornehmen können, die in anderen geschlossenen Bibliotheken nicht möglich gewesen wären.

Ausserdem kann man sich gute Inspirationen holen, was mit ST alles möglich ist, und wie man es in der Praxis umsetzt.

Vielen Dank an alle Entwickler der OSCAT.LIB für die grossartige (Pionier-)Arbeit!

# Reference

wir haben die Bibliothek bis jetzt in einer ABB-AC500 und CoDeSys eingesetzt (Notstromversorgung)  
In absehbarer Zeit werden auch Teilgebiete der Automatisierung in der Wasserversorgung Straubing von ABB-KT97 auf ABB-AC500 umgerüstet. Mit OSCAT haben wir bis jetzt viel Denk- und Handarbeit erspart, da viele Funktionen schon integriert sind.

Wink Super – weiter so

SW\_SR\_VFW (Micha)